

LGH-RVXT3-E

Commercial Series



The Commercial Lossnay (LGH) Mechanical Ventilation Heat Recovery (MVHR) systems are designed to supply clean, fresh air into commercial buildings, whilst simultaneously extracting stale air.

The **RVXT3** units offer a significantly reduced height whilst maintaining a large airflow, allowing easy installation in ceiling voids.

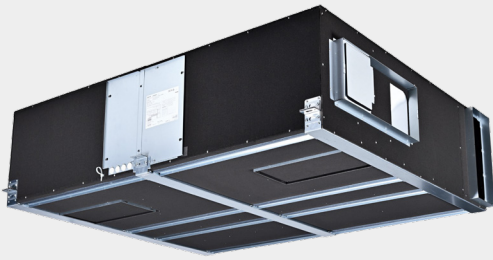

Key Features & Benefits:

- Mitsubishi Electric pioneered heat exchanger enables maximised latent heat exchange, resulting in cost and carbon savings
- Low unit height (500mm) and lightweight structure, ideal for ceiling installation
- Four commissionable fan speeds, settable between 25-100%, with independent supply and return fan control offering low running costs and easier compliance to Part L
- Optional Mitsubishi Electric energy saving CO₂ sensors allow automatic incremental fan control for a healthy indoor environment; sensors powered by Lossnay unit
- No condensate drain required allowing for easy design and installation
- Dual-barrier coated fans, prevents dust and grease accumulation, ensuring long-term efficient fan operation
- Constant pressure control available with 0-10V pressure transducer (field supplied), for variable airflow requirements across multiple zones
- Compatible with Mr Slim and City Multi air conditioning systems for a complete and highly effective system operation
- Duct handing selectable via dipswitch, for easy and flexible installation
- Optional high efficiency filters available





MODEL		LGH-160RVXT3-E	LGH-200RVXT3-E	LGH-250RVXT3-E	
25% (Default speed 1)	Air Volume	m ³ /h	400	500	625
		l/s	111	139	174
	External Static Pressure	Pa	12	12	12
	Temperature Exchange Efficiency	Heating %	88.0	86.0	84.0
		Cooling %	83.0	82.0	81.0
	Enthalpy Exchange Efficiency	Heating %	85.5	84.5	81.5
		Cooling %	78.0	75.0	73.0
	Specific Fan Power	W/(l/s)	0.41	0.40	0.50
	Input Power	W	46	56	86
	Sound Pressure Level	dB(A)	19.5	21.0	23.0
50% (Default speed 2)	Air Volume	m ³ /h	800	1000	1250
		l/s	222	278	347
	External Static Pressure	Pa	48	48	48
	Temperature Exchange Efficiency	Heating %	85.5	83.0	80.0
		Cooling %	79.0	78.0	76.5
	Enthalpy Exchange Efficiency	Heating %	83.0	81.5	78.0
		Cooling %	73.0	67.5	66.0
	Specific Fan Power	W/(l/s)	0.65	0.69	0.82
	Input Power	W	144	192	284
	Sound Pressure Level	dB(A)	26.0	28.0	31.5
75% (Default speed 3)	Air Volume	m ³ /h	1200	1500	1875
		l/s	333	417	521
	External Static Pressure	Pa	107	107	107
	Temperature Exchange Efficiency	Heating %	83.0	81.0	78.0
		Cooling %	75.0	73.0	70.5
	Enthalpy Exchange Efficiency	Heating %	81.0	79.5	76.0
		Cooling %	65.5	61.0	59.0
	Specific Fan Power	W/(l/s)	1.10	1.20	1.34
	Input Power	W	368	498	696
	Sound Pressure Level	dB(A)	33.0	35.0	38.0
100% (Default speed 4)	Air Volume	m ³ /h	1600	2000	2500
		l/s	444	556	694
	External Static Pressure	Pa	190	190	190
	Temperature Exchange Efficiency	Heating %	82.0	80.0	77.0
		Cooling %	70.0	67.5	65.0
	Enthalpy Exchange Efficiency	Heating %	80.0	78.5	75.0
		Cooling %	61.5	56.5	54.0
	Specific Fan Power	W/(l/s)	1.59	1.88	2.09
	Input Power	W	708	1044	1448
	Sound Pressure Level	dB(A)	38.0	40.0	44.0
DUCT SIZE	mm	Outlets (SA/EA): 250 x 650 / Inlets (RA/OA): 465 x 220			
WEIGHT	kg	172	172	172	
DIMENSIONS	Width x Depth x Height	2100 x 1600 x 500			
ELECTRICAL POWER SUPPLY		3-phase, 380-415V, 50Hz ²			
MAXIMUM CURRENT	A	3.0	3.9	5.0	
HEAT EXCHANGER		Paper with Specially Treated Cellulose Membrane			
STANDARD FILTER		ISO 16890 Coarse 60% ¹			

Notes: Running current, power consumption, recovery efficiency, and sound levels are based on the above default airflow rates at 25%, 50%, 75%, and 100%. Specific duty point data is available upon request. Supply and exhaust fan speeds can be individually commissioned between 25% and 100% in 5% increments. Sound Pressure Level measured at 1.5m under the centre of the bottom panel. Air flow rates, external static pressure and specific fan powers tested to BS EN13053: 2019. Energy recovery efficiencies tested to BS EN308: 2022.

¹: EN 779 G4 equivalent according to 'REHVA Filter Class Conversion between EN 779 and EN ISO 16890-1'

²: 3 phase 4 wire power must be connected. The unit only uses loads L2 and L3, meaning L1 does not draw load

ACCESSORIES		LGH-160RVXT3-E	LGH-200RVXT3-E	LGH-250RVXT3-E
Remote Controller			PZ-62DR-EB	
Filters	Standard Replacement Filter (Coarse 60%)		PZ-250TRF-E	
	ISO 16890 ePM1 75%, ePM2.5 80%, ePM10 95%		PZ-250TPF-E	
CO ₂ Sensors		PZ-70CSW-E (Wall mounted) / PZ-70CSD-E (Duct mounted)		
External signal relay			PZ-4GS-E	



LGH-160RVXT3-E SOUND POWER OCTAVE LEVELS

Case Radiated Breakout

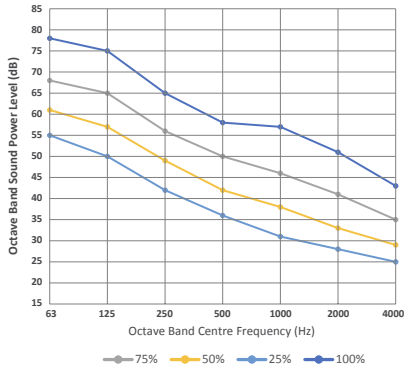

In-Duct Outlet (Supply Air & Exhaust Air)

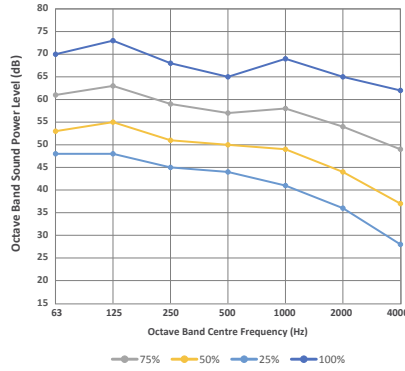

In-Duct Outlet (Return Air & Outside Air)

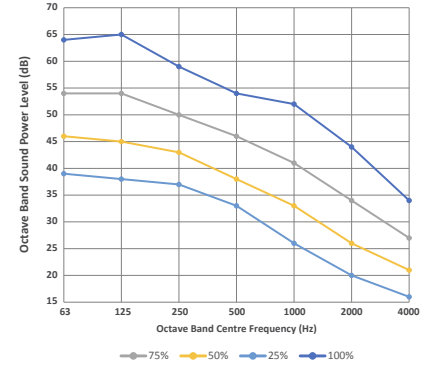

LGH-200RVXT3-E SOUND POWER OCTAVE LEVELS

Case Radiated Breakout

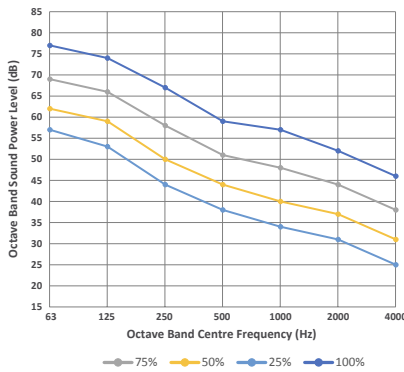

In-Duct Outlet (Supply Air & Exhaust Air)

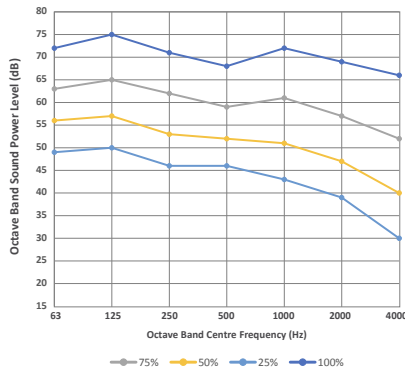

In-Duct Outlet (Return Air & Outside Air)

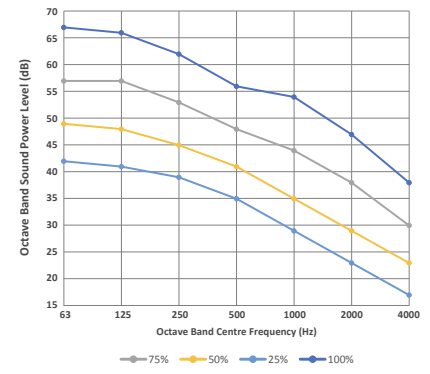

LGH-250RVXT3-E SOUND POWER OCTAVE LEVELS

Case Radiated Breakout

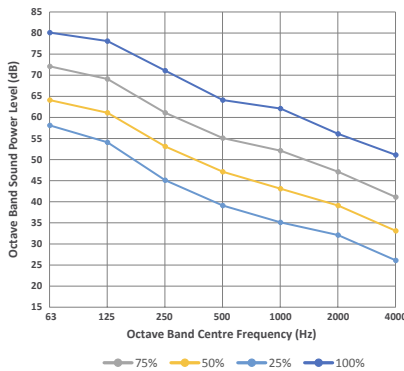

In-Duct Outlet (Supply Air & Exhaust Air)

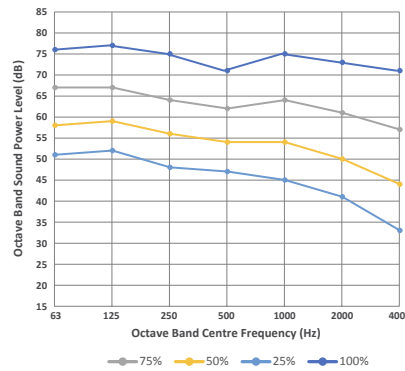

In-Duct Outlet (Return Air & Outside Air)

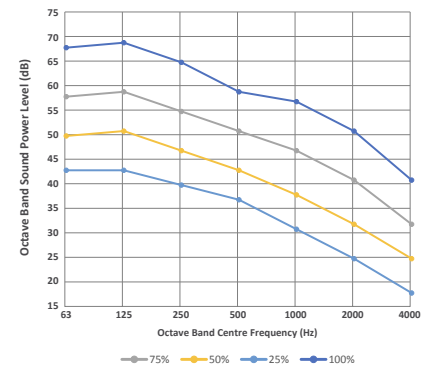

Notes:
Sound power octave band test based on ISO 3744:2010 at standard operating conditions. For duty point specific data contact Mitsubishi Electric.
Measurements below 15dB are shown as <15 in the table and omitted from the graph.



LGH-160/200/250RVXT3-E DIMENSIONS

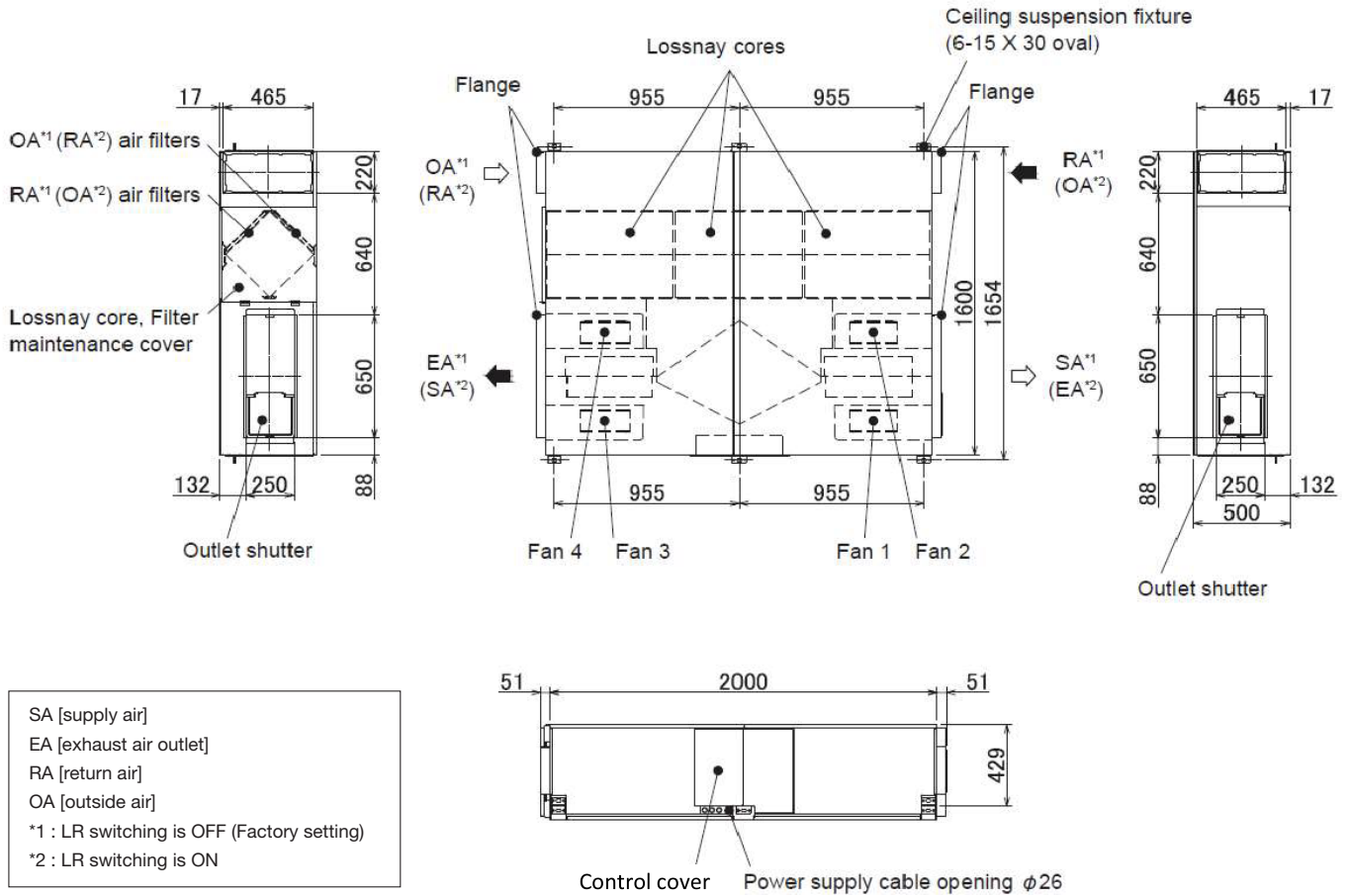

Telephone: 01707 282880
email: air.conditioning@meuk.mee.com
les.mitsubishielectric.co.uk



UNITED KINGDOM Mitsubishi Electric Europe Living Environment Systems Division, Travellers Lane, Hatfield, Hertfordshire, AL10 8XB, England. Telephone: 01707 282880 Fax: 01707 278881
IRELAND Mitsubishi Electric Europe, Westgate Business Park, Ballymount, Dublin 24, Ireland. Telephone: (01) 419 8800 Fax: (01) 419 8890 International code: (003531)

Country of origin: United Kingdom - Italy - Turkey - Japan - Thailand - Malaysia. ©Mitsubishi Electric Europe 2024. Mitsubishi and Mitsubishi Electric are trademarks of Mitsubishi Electric Europe B.V. The company reserves the right to make any variation in technical specification to the equipment described, or to withdraw or replace products without prior notification or public announcement. Mitsubishi Electric is constantly developing and improving its products. All descriptions, illustrations, drawings and specifications in this publication present only general particulars and shall not form part of any contract. All goods are supplied subject to the Company's General Conditions of Sale, a copy of which is available on request. Third-party product and brand names may be trademarks or registered trademarks of their respective owners.

Note: The fuse rating is for guidance only and please refer to the relevant databook for detailed specification. It is the responsibility of a qualified electrician/electrical engineer to select the correct cable size and fuse rating based on current regulation and site specific conditions. Mitsubishi Electric's air conditioning equipment and heat pump systems contain a fluorinated greenhouse gas, R410A (GWP:2088), R290 (GWP:3), R32 (GWP:675), R407C (GWP:1774), R134a (GWP:1430), R513A (GWP:631), R454B (GWP:466), R454C (GWP:148), R1234ze (GWP:7) or R1234yf (GWP:4). *These GWP values are based on Regulation (EU) No 517/2014 from IPCC 4th edition. In case of Regulation (EU) No.626/2011 from IP CC 3rd edition, these are as follows. R410A (GWP:1975), R32 (GWP:550), R407C (GWP:1650) or R134a (GWP:1300).

Effective as of September 2024

